

## OPCom Portable Oil Lab

PPCO 300-1000



### Safety and operating instructions

**Read the safety and operating instructions before use.**

**Note:** The indicated data only serve to describe the product. Information regarding the use of this product are only examples and suggestions. Catalog specifications are no guaranteed features. The information given does not release the user from his / her own assessments and inspection. Our products are subject to a process of natural wear and aging.

© All rights are reserved by ARGO-HYTOS GMBH, even in the event of industrial property rights. Any right of disposal such as copying and distribution rights shall remain with us.

The picture on the title page shows a configuration example. The delivered product may thus differ from the illustration.

**Original operating instructions**

# Contents

<b>Contents</b> .....	<b>2</b>
<b>1. About this documentation</b> .....	<b>4</b>
1.1 Applicability of this documentation.....	4
1.2 Required and supplementary documentation.....	4
1.3 Presentation of information.....	4
1.3.1 Safety instructions in this documentation.....	4
1.3.2 Symbols.....	5
<b>2. Safety instructions</b> .....	<b>6</b>
2.1 About this chapter.....	6
2.2 Intended use.....	6
2.3 Improper use.....	6
2.4 Reasonably foreseeable misuse.....	6
2.5 Qualification of personnel.....	6
2.6 General safety instructions.....	7
2.7 Product and technology related safety instructions.....	7
<b>3. General instructions</b> .....	<b>8</b>
<b>4. Scope of delivery</b> .....	<b>9</b>
<b>5. About this product</b> .....	<b>10</b>
5.1 Functional description.....	10
5.2 Measured values.....	10
5.3 Component overview.....	11
5.4 Controls.....	12
5.5 Control panel.....	12
5.6 Printer.....	13
5.4 Identification of the product.....	13
<b>6. Transport and storage</b> .....	<b>14</b>
<b>7. Assembly</b> .....	<b>15</b>
7.1 Operating site.....	15
7.2 Hydraulic connection.....	15
7.3 Electrical connection.....	17
7.4 Charging process.....	18
<b>8. Commissioning</b> .....	<b>19</b>
8.1 Before commissioning.....	19
<b>9. Operation</b> .....	<b>20</b>
9.1 Operation.....	20
9.2 Menu structure.....	21
9.2.1 Switching on the device.....	23
9.2.2 Start screen.....	24
9.2.3 Measurement quick menu.....	25
9.2.4 Memory quick menu.....	25
9.2.5 Main menu.....	26
9.2.5.1 Memory menu.....	26
9.2.5.2 Measurement settings.....	28
9.2.5.3 System settings.....	31
9.2.5.4 Select start screen.....	31

9.2.5.5	Print selection .....	33
9.2.5.6	Display .....	35
9.2.5.7	Time / date .....	36
9.2.5.8	Language.....	36
<b>10.</b>	<b>Maintenance / repair .....</b>	<b>37</b>
10.1	Maintenance.....	37
10.2	Repair .....	37
10.3	Spare parts.....	37
<b>11.</b>	<b>Software .....</b>	<b>38</b>
<b>12.</b>	<b>Decommissioning .....</b>	<b>39</b>
<b>13.</b>	<b>Disassembly .....</b>	<b>40</b>
<b>14.</b>	<b>Disposal.....</b>	<b>41</b>
14.1	Environmental protection .....	41
<b>15.</b>	<b>Extension and conversion .....</b>	<b>42</b>
15.1	Accessories .....	42
<b>16.</b>	<b>Troubleshooting .....</b>	<b>43</b>
16.1	Basic procedures .....	43
<b>17.</b>	<b>Technical data .....</b>	<b>44</b>
17.1	Dimensional drawing .....	45
<b>18.</b>	<b>Appendix .....</b>	<b>46</b>
18.1	Declaration of conformity.....	46

## 1. About this documentation

### 1.1 Applicability of this documentation

This documentation is applicable for the following product:

- › Particle Monitor OPCom Portable Oil Lab

This documentation is written for service engineers, technicians, operators and system operators.

This document contains important information for safe and appropriate assembly, transport, activation, operation, usage, servicing, dismantling and simple troubleshooting.

- › Read this document completely and in particular Chapter 2, "Safety Instructions", before you work with the product.

### 1.2 Required and supplementary documentation

- › Do not commission the product until you have received the documentation marked with the book icon and you have understood and complied with the information therein.

	Title	Number of document	Document type
	Data sheet	100.60	Data sheet

Table 1: Required and supplementary documentation

### 1.3 Presentation of information

So that this document can help you to work quickly and safely with your product, we use standardized safety instructions, symbols, terms and abbreviations. For better understanding, these are explained in the following sections.

#### 1.3.1 Safety instructions in this documentation

In this documentation, safety instructions are faced with a sequence of actions which would result in the danger of personal injury or damage to equipment. The measures described to avoid these hazards must be observed.

Safety instructions are structured as follows:

 <b>SIGNAL WORD</b>
<b>Type and source of danger</b> Consequences of non-compliance › Measures for safety and hazard defense › <List>

- › Warning signal: draws attention to the danger
- › Signal word: indicates the severity of the danger
- › Type and source of danger: specifies the type and source of danger
- › Consequences: describes the consequences of non-compliance
- › Measures: describes how to deal with the risk



Warning sign, signal word	Meaning
 <b>DANGER</b>	Indicates a dangerous situation which results in death or serious injury if not avoided.
 <b>WARNING</b>	Indicates a dangerous situation which may result in death or serious injury if not avoided.
 <b>CAUTION</b>	Indicates a dangerous situation which may result in light to moderate injury if not avoided.
<b>NOTE</b>	Indicates equipment damage: The product or surrounding could be damaged.

Table 2: Danger classes acc. ANSI Z535.6-2006

### 1.3.2 Symbols

The following symbols indicate notes which are not safety-relevant but increase the intelligibility of the documentation.



Symbol	Meaning
	If this information is not observed, the product cannot optimally be used or operated
	This symbol warns against laser beams.
	Singular, independent action step / instruction
<ol style="list-style-type: none"><li>1.</li><li>2.</li><li>3.</li></ol>	Numbered instruction The numbers indicate that the action steps follow one another

Table 3: Meaning of symbols

## 2. Safety instructions

### 2.1 About this chapter

This product was manufactured according to the generally recognized standards of engineering. Nevertheless, there is a danger of injury or damage if you do not observe this chapter and the safety instructions in this documentation.

- ▶ Read this document thoroughly and completely before working with the product.
- ▶ Retain this document and ensure that it is available for all users at all times.
- ▶ Always include the necessary documentation when passing the equipment along to a third party.

### 2.2 Intended use

This product is a hydraulic component.  
The device serves to monitor the condition of fluids.

You may use the product for the following:

- › Condition monitoring of a fluid

The product is intended for professional use only, not for private use.

"Intended use" also includes that you have completely read and understood this documentation, in particular Chapter 2 "Safety Instructions".

### 2.3 Improper use

Any other use than the intended use described, is improper and therefore inadmissible.

If unsuitable products are installed or used in safety-related applications, unintended operating states can occur in the application, which can cause personal injury and / or material damage. Therefore only use this product in safety-related applications if this use is expressly specified and permitted in the product's documentation, e.g. in explosion protection areas or in safety-related parts of a control system (functional safety).

ARGO-HYTOS GMBH assumes no liability for damages resulting from improper use.  
The risks associated with improper use are solely with the user.

### 2.4 Reasonably foreseeable misuse

The delivery of the following media is forbidden:

- › Others than listed in Chapter 18.1 "Technical Data".

The operator alone is liable for damages resulting from improper use.

### 2.5 Qualification of personnel

The operations described in this document require fundamental knowledge of mechanics and hydraulics as well as knowledge of the appropriate technical terms. In order to ensure safe use, these operations may therefore only be carried out by a correspondingly skilled worker or an instructed person under the guidance of a skilled worker.

A skilled worker is someone who can - based on his / her technical education, knowledge and experience as well as knowledge of the respective regulations of the jobs assigned to him / her - recognize possible dangers and ensure appropriate safety measures. A skilled worker must observe the relevant technical regulations.

## 2.6 General safety instructions

- › Observe the valid regulations for accident prevention and environmental protection.
- › Observe the safety regulations and requirements of the country in which the product is used / applied.
- › Only use ARGO-HYTOS products that are in technically perfect condition.
- › Observe all instructions on the product.
- › People who assemble, operate, disassemble or maintain ARGO-HYTOS products may not do so under the influence of alcohol, other drugs or medications that affect the responsiveness.
- › Only use manufacturer-approved accessories and spare parts, in order to prevent personal danger due to unsuitable spare parts.
- › Observe the technical data and ambient specifications specified in the product documentation.
- › If unsuitable products are used or installed in safety-relevant applications, unintended operating states can occur in the application, which can cause personal injury and / or material damage. Therefore only use the product in safety-relevant applications if this use is expressly specified and permitted in the product's documentation.
- › You may only put the product into operation, when it has been established that the final product (e.g. a machine or system), into which the ARGO-HYTOS products are installed, complies with the country-specific regulations, safety regulations and standards of the application.

## 2.7 Product and technology related safety instructions



### CAUTION

#### Laser

The OPCom Portable Oil Lab contains a laser sensor that is classified for intended use as a class 1 laser according to DIN EN 60825-1:2001-11.

In reasonably foreseeable circumstances, the accessible laser radiation is not dangerous.

- ▶ With direct exposure to class 1 lasers in the upper power range, injury, such as blinding, impairment of color vision and disruption, cannot be ruled out.

#### For prevention of material damage and product damage



#### CAUTION

##### **Danger due to improper handling**

Material damage

- ▶ The Particle Monitor may only be used in accordance with Section 2.2, "Intended use".

##### **Leakage or spillage of hydraulic fluid**

Environmental pollution and ground water pollution

- ▶ Use oil binding agents in order to bind leaked hydraulic oil.

##### **Contamination due to fluids and foreign bodies**

- ▶ Premature wear - malfunction - risk of damage - material damage
- ▶ Pay attention to cleanliness when assembling in order to prevent foreign bodies, such as welding beads or metal chips, from entering the hydraulic lines and leading to premature wear or malfunction.
- ▶ Make sure that connections, hydraulic lines and attachment parts (e.g. gauges) are free of dirt and chips.
- ▶ Check prior to commissioning that all hydraulic and mechanical connections are connected and tight and that all gaskets and seals of the plug connectors are correctly assembled and undamaged.
- ▶ For removal of lubricants and other contaminants, use residue-free industrial wipes.
- ▶ Make sure that connections, hydraulic lines and attachment parts are clean.
- ▶ Ensure that no contaminants enter when closing the connections.
- ▶ Make sure that no detergents enter the hydraulic system.
- ▶ Do not use cotton waste or faying cleaning rags for cleaning.
- ▶ Do not use hemp as sealing agent.



## 4. Scope of delivery

The package includes:

- › 1 OCom Portable Oil Lab
- › 1 Operating manual
- › 1 Power supply 100-240 VAC
- › 1 Power cable
- › 1 Low-pressure hose set including connection couplings
- › 1 High-pressure hose



Fig. 1: Scope of delivery

## 5. About this product

### 5.1. Functional description

The OPCom Portable Oil Lab is a mobile oil laboratory for service, with which oil cleanliness and oil condition in hydraulic and lubricating systems can be examined.

The OPCom Portable Oil Lab enables measuring of particles to the latest standards and indicates the cleanliness classes in accordance with ISO 4406:1999 and SAE AS4059.

Additionally it displays the relative humidity and oil temperature. Optionally, further information about the oil condition can be obtained from the conductivity and permittivity of the oil and shown on the integrated display.

The OPCom Portable Oil Lab is an optical particle monitor that works according to the principle of light absorbance. The use of the OPCom Portable Oil Lab allows the monitoring of contaminant levels as well as the observance of the trend of changes in fluid cleanliness. With this, in the most precise cases, differences can occur compared to particle monitors that are calibrated to ISO 11171:99. The discrepancy is, however, smaller than an ordinal number. Variances are very precisely indicated.

Through continual monitoring of fluid conditions, changes in the machine can be detected very quickly. With quick warning, measures can be taken to prevent increased contamination, which can lead to possible damage to the hydraulic system.

### 5.2 Measured values

The following values are determined during a measurement:

Parameter	Abbreviation	Unit	Description
Temperature coefficient	T	°C / °F	Fluid temperature
rel. permittivity (rel. DK)	P		The relative permittivity is a parameter for the polarity of the fluid. Oils change their polarity during the aging process.
Conductivity	C	pS/m	Fresh oils show a characteristic conductivity. Oil change, oil mixtures and oil deposits can be detected by their conductivity.
rel. oil humidity	RH	%	Relative humidity between 0 und 100 %
Cleanliness level acc. to ISO	ISO		Indicates the respective ordinal number (OZ) according to ISO 4406:99
Cleanliness level acc. to SAE	SAE		Indicates the respective ordinal number (OZ) according to SAE AS4059
Cleanliness level acc. to NAS	NAS		Indicates the respective ordinal number (OZ) following NAS 1638
Cleanliness level acc. to GOST	GOST		Indicates the respective ordinal number (OZ) following GOST 17216
Concentration	Conc	p/ml	Indicates the number of particles per milliliter
Flow index	FIndex	ml/min	Calculated volume flow

### 5.3 Component overview

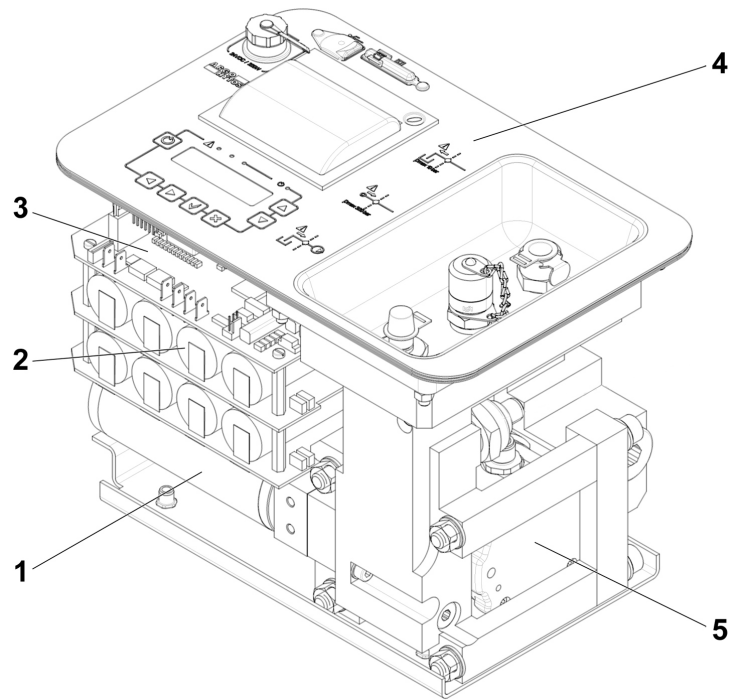

1 Motor with pump and electric gear

2 Rechargeable battery pack

3 Control electronics

4 Top side with control panel

5 Particle monitor

6 Oil condition sensor (not displayed)

#### 1 Motor with pump

Pumps the fluid from the supply line through the device to the return line.

#### 2 Rechargeable battery pack

Energy source for operation without a power adapter, as well as for operation both with and without the pump.

#### 3 Control electronics

The control electronics include battery management, supply connections and various measuring functions.

#### 4 Control panel

In the case of an alarm, this indicator lights up red.

Observe the instructions in the course of this operating manual (Chapter 9).

#### 5 Particle monitor

The device is an optical particle monitor, used for the monitoring of the fluid cleanliness. It works according to the principle of light extinction (reduction of light radiation) and detects particles and other foreign bodies in the fluid.

#### 6 Oil condition sensor

The oil condition sensor measures changes in the features of the hydraulic and lubricating medium (conductivity, permittivity) along with concurrent humidity and temperature measurements.

## 5.4 Controls

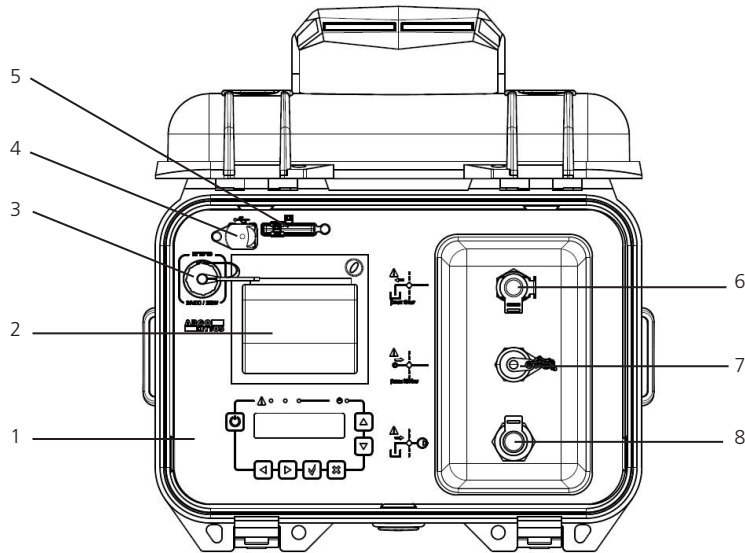

- 1 Control panel
- 2 Printer
- 3 Charger connection
- 4 USB-B connection
- 5 SD card slot
- 6 Oil out CPC-LC
- 7 Pressure line Minimess® M16x2
- 8 Suction line internal pump CPC-LC

Fig. 3: Control elements

## 5.5 Control panel

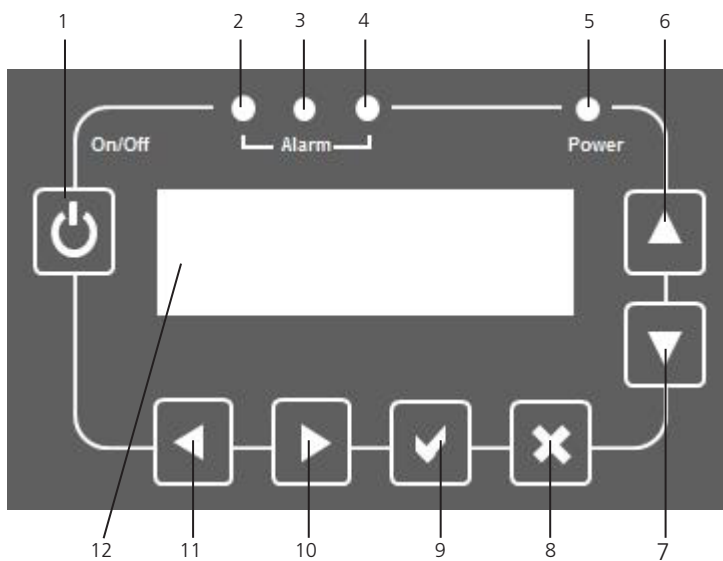

Fig. 4: Control panel

- 1 Power button
- 2 Alarm-LED green
- 3 Alarm-LED yellow
- 4 Alarm-LED red
- 5 Standby indicator
- 6 Select previous menu item / numerical value
- 7 Select next menu item / numerical value
- 8 Cancel button
- 9 Confirm button
- 10 Select previous data record / numerical value in the menu
- 11 Select next data record / numerical value in the menu
- 12 Display

## 5.6 Printer

Data can be printed out with the printer.



- The blue button on the top right above the printer (see arrow)
- › signals the operational readiness of the printer
  - › initiates the line feed by pressing it

Fig. 5: Printer

Paper changing

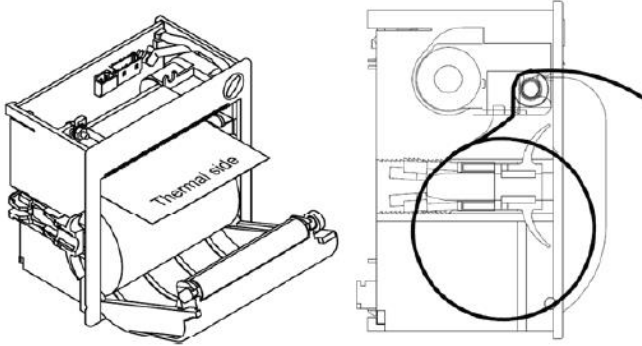

Pull the flap in order to open the cover.  
Then replace the paper roll and insert the paper as shown in the figure.

## 5.7 Identification of the product

**OPCom**  
**Portable Oil Lab**

**ARGO**  
**HYTOS**

24VDC max. 8A

[www.argo-hytos.com](http://www.argo-hytos.com)

Made in Germany

Mat.-Nr.: 288816xx

SN: >serial number<

2D Code

Fig. 6: Label



Fig. 7: Transport

The case can be closed with the fastening hooks (4).

The transport case is equipped with a pressure compensating valve (3).

A handle is embedded in the lid (2).

Alternatively, the transport case may be transported with a shoulder strap, which can be fastened to the movable belt mounts (1) (see Chapter 15.1 accessories).

There are no special transport notes for this product.

- ▶ In the case of air transport, it must be stated in the air waybill that the device contains lithium batteries.
- ▶ Observe the instructions in Chapter 2, "Safety instructions".
- ▶ For storage and transport, keep the OPCom Portable Oil Lab within the ambient conditions that are stated in Chapter 17, "Technical data".

### 7.1 Operating site

Please follow these instructions when determining the operating site:

- › The installation location of the device is variable. These can be:
  - 1) Measuring point at a pressure line.  
This measuring point should be representative of the machine. The device itself provides the necessary volume flow via an integrated volumetric flow controller.
  - 2) Measuring a sample from a tank or a bottle over the pump.

Connect the device to a pressure line in the off-line flow by means of a T-junction.

- › At the connection point, constant pressure conditions should prevail. The pressure may vary, but pressure peaks or strong fluctuations must not occur.
- › The connection to the control line is recommended, alternatively the filter or cooling circuit is suitable.

### 7.2 Hydraulic connection



#### Danger due to improper handling

Material damage.

- ▶ Always connect the oil return first.

The device is provided with three connections.

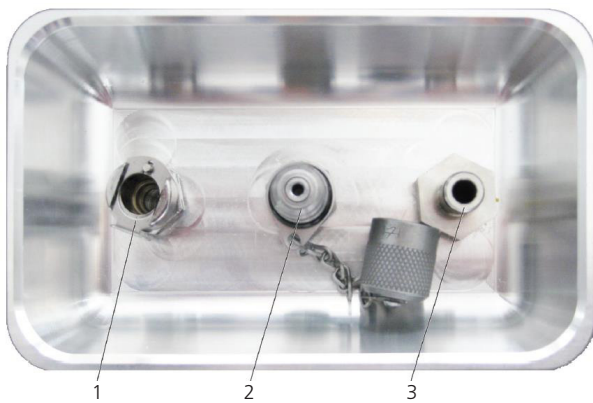

Fig. 8: Hydraulic connections

- 1 Oil outlet CPC-LC
- 2 Pressure line Minimes M16x2 (for operation without pump), max. 320 bar / 4600 psi
- 3 Suction line CPC-LC (for operation with internal pump)

### 1 Oil outlet

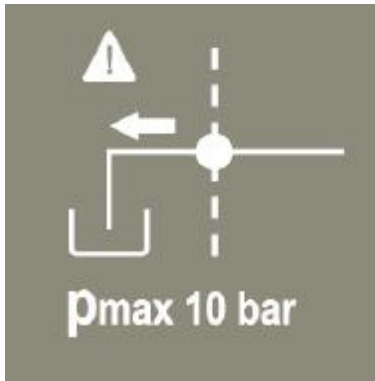

Fig. 9: Oil outlet

This is a CPC-LC coupling with slide protection, which prevents unintended unlocking of the plug-in nipple. In order to unplug the hose from the coupling, the slider (see arrow) must be pressed in the direction of the intake hole.

After use, close the connection with the included sealing plug.

### 2 Pressure line (for operation without pump)

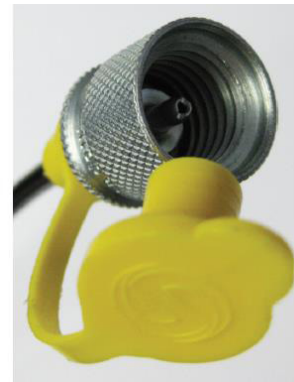

Fig. 10: Pressure line (for operation without pump)

When the pressure in the oil suction line is sufficiently high (min. 10 bar (145 psi) / max. 320 bar (4600 psi) / min. 50 ml/min depending on viscosity), the oil inlet can be attached to this Minimes pressure connection (M16x2).

### 3 Suction line (for operation with internal pump)

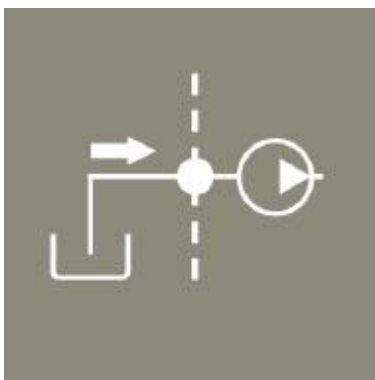

Fig. 11: Suction line (for operation with pump)

After use, close the connection with the included sealing plug.





**DANGER**

Risk of death

Danger of electrical shock.

- ▶ The electrical connection of the portable particle monitor may only be performed by a qualified electrician.



**WARNING**

Faulty power supply

Risk of death - injury

- ▶ Always consider the country-specific prescriptions.

Power supply according to EN50178, SELV, PELV, VDE0100-410/A1.

The OPCom Portable Oil Lab works with battery as well as with connected power.

In battery mode, the cells supply the necessary power.

They are charged by connecting a power cord to the charging connection.

Once the power has been connected to the OPCom Portable Oil Lab, this is switched on independently without having to press the power button.



Fig. 12: Electrical connection

Preparing the network operation

- › Insert the polarity-proof plug with the blue locking ring (2) into the charging port of the switched off OPCom Portable Oil Lab and screw it down.
- › Plug the "cold-device plug" (3) (according to IEC60320-C13) into the power supply (1).
- › Connect the power plug (4) to the local power supply.

#### 7.4 Charging process

Please note the following procedure to ensure correct charging.

1. Open the cover of the device.
2. Connect the charger connector of the device to the power supply
3. Connect the power supply to the supply network (100-240 VAC), then a plug symbol is shown on the display.
4. To ensure a full charge, the device must be connected to the power cable for at least 1 h.
5. When a charging state of 100 % is reached, the charging circuit automatically terminates the charging.

Please note that the device cannot be switched off while charging due to technical reasons.

When operating without pump, the runtime is min. 24 hours, with pump operation the runtime reduces depending on the viscosity of the medium.

### 8.1 Before commissioning

Be sure to read and understand the operating manual before putting the device into operation.

- ▶ The information for intended use, the operating conditions and the technical specifications must be adhered to.
- ▶ Connect the portable Particle Monitor OPCOM Portable Oil Lab to the hydraulic connection lines according to Chapter 7.2 "Hydraulic connection" .
- ▶ Cables and hoses must be outside of the movement range of the operating personnel (tripping hazard).

9.1 Operation

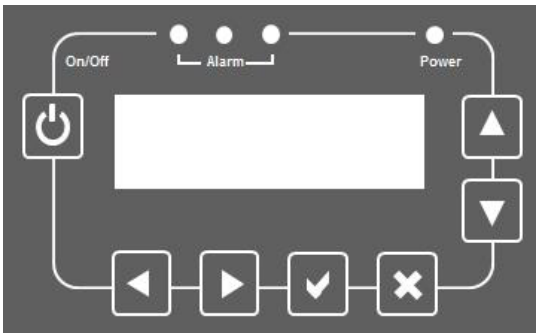

Fig.13: Control panel

Button	Functions
	To turn the device on / off
	To confirm a selected option / value
	To cancel the current input / back
	Within the menu: scroll up
	Within the menu: scroll down
	To select next data set / numerical value in menu
	To select previous data set / numerical value in menu

9.2 Menu structure

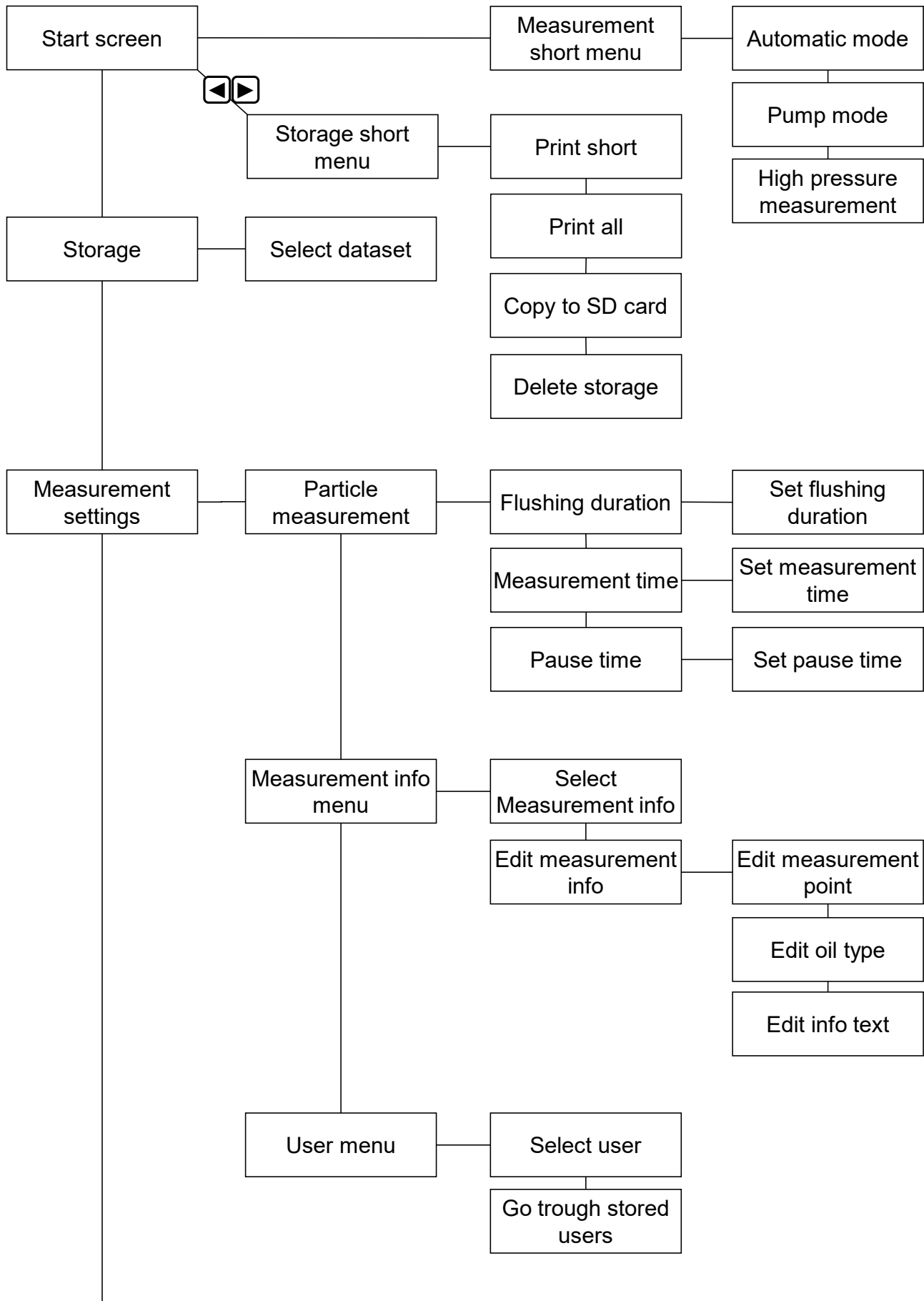
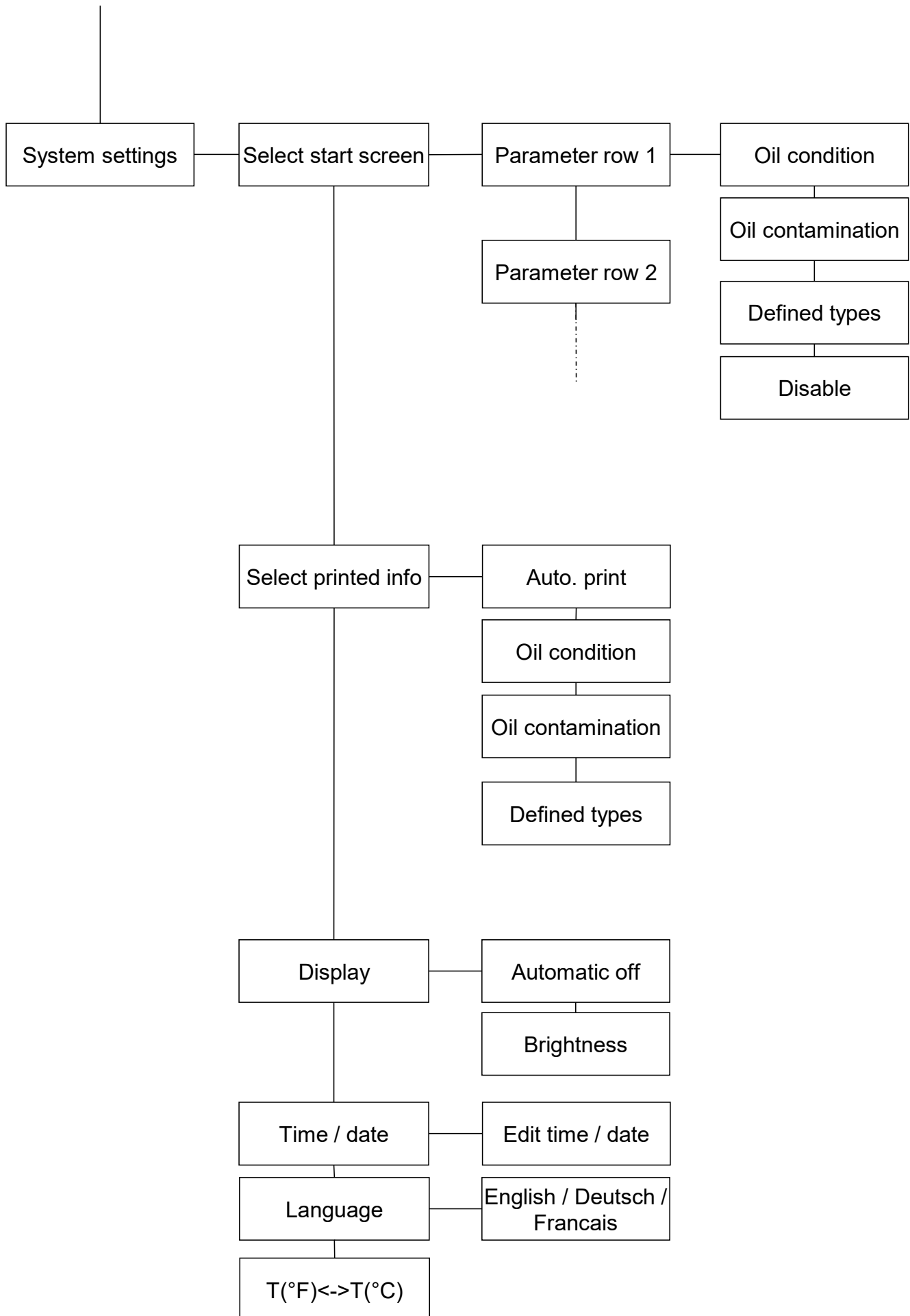



Fig. 15: Menu structure Part 1



### 9.2.1 Switching on the device

To turn on the device, press the  button and hold it down until the standby signal lights up. The welcome screen will appear:



During a short initialization phase, the display shows the version screen, which provides information on the implemented software.



After the device has been initialized, the following values are displayed:

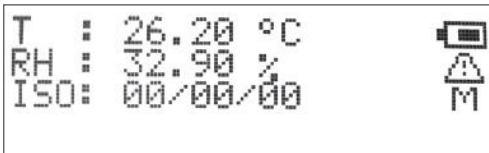

The following data are shown on the display:

Temperature T [°C]  
Relative oil humidity RH [%]  
ISO 4 µm, 6 µm, 14 µm (according to ISO 4406: 1999)

The mode icon at the bottom right shows the current function mode of the device.

- › If an "M" is displayed, the device is in manual mode, which means that the measurement must be started automatically.
- › If an "A" is displayed, the device is in automatic mode, which means that the measurement is started automatically.

The setting for this mode is explained in Chapter 9.2.3 "Measurement quick menu".

In case of battery operation, the current charge of the battery cells is displayed with a status bar: 

When the device is plugged in, the charging sign  is displayed.

If necessary - if the bar decreases - a power supply must be connected (see Chapter 7.3 "Electrical Connection").

The symbol  shows, that a warning or note has occurred during the last measurement.

The warnings can be taken from the main menu - sub-item "Memory". The meaning of the notes / warnings is explained in Chapter 9.2.5.1.

## 9.2.2 Start screen

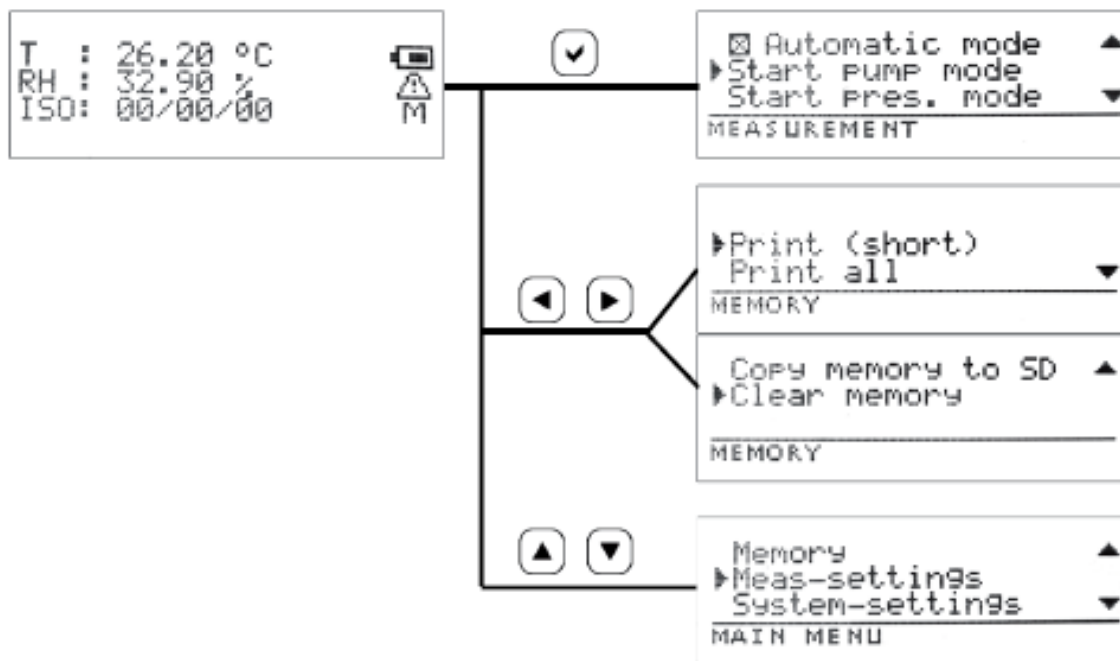

- › By pressing the  button, you enter the quick menu "Measuring" (see Chapter 9.2.3).
- › By pressing the  or  button, you enter the quick menu "Memory"(see Chapter 9.2.4).
- › By pressing the  or  button, you enter the „Main Menu“ (see Chapter 9.2.5).

When a measuring is running:

- › By pressing the  button in the start screen, you stop the measurement.

When no measuring is running:

- › By pressing the  button, you return to the start screen.



### 9.2.3 Measurement quick menu

```
☒ Automatic mode ▲
▶ Start PUMP mode
Start Pres. mode ▼
-----
MEASUREMENT
```

By pressing the  or  button, you select the desired menu item.

By pressing the  button, you return to the start screen.

#### Automatic mode

The automatic mode can be switched on or off by setting a check mark with the  button.

The corresponding mode is indicated by an "M" (manual mode) or "A" (automatic mode) in the value display (see Chapter 9.2.1. "Switching on the device").

#### Pump measurement

Press the  key to start a measurement using the pump.

The corresponding mode is indicated by the symbol  in the value display. A progress bar graphically displays the progress of the measurement.

#### High pressure measurement

The  key is used to start a measurement with high pressure, i.e. without using the pump.

The corresponding mode is indicated by the symbol "P" in the value display. A progress bar graphically displays the progress of the measurement.

### 9.2.4 Memory quick menu

```
▶ Print (short)
Print all ▼
-----
MEMORY
```

```
Copy memory to SD ▲
▶ Clear memory
-----
MEMORY
```

By pressing the  or  button, you select the desired menu item.

By pressing the  button, you return to the start screen.

#### Printing (short)

After selecting this option, press the  button to print a filtered selection.

The parameters of the last data record defined in "System Settings" (Chapter 9.2.5.3 "System settings" / "Selection Print") are printed.

#### Print (all)

After selecting this option, press the  key to print all parameters of the last record.

#### Copy to SD

All stored values are copied to the SD card, if an SD card is inserted.

#### Clear memory

Press the  button in order to clear the internal memory of the device.

The progress of the erasure process is represented by means of a progress bar.

After successful completion of the erasure process, the message "Successful" appears and the display automatically returns to the measuring menu.

## 9.2.5 Main menu

```
Memory ▲
Meas-settings
System-settings ▼
-----
MAIN MENU
```

By pressing the  or  button, you select the desired menu item.

By pressing the  button, you return to the value display.

### 9.2.5.1 Memory menu

After selecting this option, press the  button to print the displayed data set.

If no values are stored, this display is empty.

In this case, no further menu selection can be made as described below.

Press the  or  buttons to change the record.

Press the  or  buttons to scroll through the currently selected record.

The following parameters are displayed:

#### › Time / Date / User

```
Time      :16:33:26
Date      :18.10.13  ⬆
User      :user1    ▼
-----
MEMORY    0199/0199
```

#### › Measuring info (M / O / I)

M: Measuring point (Measuring point 1, Measuring point 2 ...)

Oil type HLP ... (Oil designation)

Info text (see Chapter 9.2.5.2 "Measurement settings - Measuring info menu")

```
Meas pt :MP01    ▲
Oiltype :         ⬆
Infotext:        ▼
-----
MEMORY    0199/0199
```

#### › Measured values oil condition

T: Temperature

P: Relative dielectric constant

C: Conductivity

RH: Relative oil humidity

```
T      : 54.60 °C  ▲
P      : 2.133     ⬆
C      : 1317 PS/M ▼
-----
MEMORY    0199/0199
```

```
RH     : 7.200 %  ▲
-----
MEMORY    0199/0199
```

- › Measured values oil contamination
- ISO 4, 6, 14, 21 Cleanliness class according to ISO
- SAE 4, 6, 14, 21 Cleanliness class according to SAE
- NAS Cleanliness class according to NAS
- GOST Cleanliness class according to GOST
- Conc 4, 6, 14, 21 Concentration
- F<sub>index</sub> Flow index

```

ISO4um : 20 ▲
ISO6um : 18 ⇄
ISO14um : 15 ▼
-----
MEMORY 0199/0199

```

- › Info text

```

No notes ▲
          ⇄
-----
MEMORY 0199/0199

```

- › Notes on measurement

These notes are stored in the device.

After a measurement the following information can be given:

#### Alarm condition RED

No.	Description
0	Low oil level
4	Free water (>95%)
5	Extreme water content (>75%)
6	High temperature (>80°C)
9	High volume flow index (<500 ml/min)
10	Low volume flow index (<50 ml/min)
48	Particle measurement laser current too high
49	Laser current too low
50	Photodiode voltage too low
51	Photodiode voltage too high

#### Alarm condition YELLOW



No.	Description
20	High water content (>50%)

#### No alarm display / GREEN

No.	Description
25	Temperature outside the measuring range
26	Humidity outside the measuring range
27	Conductivity outside the measuring range
28	Permittivity outside the measuring range
53	Incorrect temperature measurement
52	Incorrect humidity measurement
54	Incorrect conductivity measurement
55	Incorrect permittivity measurement
7	High average temperature
49	Defective condition sensor

Please also refer to Chapter 16 - Troubleshooting

### 9.2.5.2 Measurement settings

Press the  or  buttons to select the desired menu item.

Press the  button to return to the main menu.

```
Particle counting ▲
▶Measuring info
Username ▼
-----
SYSTEM-SETTINGS
```

Particle measurement

After selecting this option, press the  button to enter the flushing, measuring and pause times.



```
Flushing 010s ▲
▶Meas. time 060s
Pause time 010s ▼
-----
MEASURING INFO
```



Flushing time

After selecting the "Flushing time" option, you can set the flushing time. After changing the oil sample, rinse for at least 2 min.

```
Flushing 010s
          ▼
          ▲
-----
MEASURING INFO
```

Here, enter the flushing time in seconds.

With the  or  button, you can choose a different item.

With the  or  button, you can raise or lower the value.



Confirm the selection by pressing the  button.



Measuring time

After selecting the "Measuring time" option, you can set the measuring time.  
The measurement must not be less than 30 seconds.

```
Meas. time 060s
          ▼
          ▲
-----
MEASURING INFO
```

Here, enter the measuring time in seconds.

With the  or  button, you can choose a different item.

With the  or  button, you can raise or lower the value.



Confirm the selection by pressing the  button.



### Pause time

After selecting the "Pause time" option, you can set the pause time. The pause time can be set depending on the desired measuring interval. However, it is only applied when the automatic mode is used. After each measurement, the pump is switched off for the selected time before a new measurement starts.

```
Pause time 010s
-----
MEASURING INFO
```

Here, enter the pause time in seconds.

With the  or  button, you can choose a different item.

With the  or  button, you can raise or lower the value.

Confirm the selection by pressing the  button.

### Measuring info menu

```
▶ M: MP03
  O: HLP46
  I:
-----
MEASURING INFO 03/10
```

The measuring info menu is used to enter user-defined values.

For max. 10 measuring points, a name for the measuring point, the oil type as well as a freely selectable info text can be stored.

These data are stored and can be queried (see Chapter 9.2.5.1 "Memory menu" / under "Measuring info").

### Choosing the measuring point

Use the  or  button to scroll through the menu.

```
▶ □ M: MP02
  O:
  I:
-----
MEASURING INFO 02/10
```

The measuring point can be selected with .

If the measuring point has already been selected, the measuring point can be edited by pressing  again.

### Entering / changing the measuring point

After the selection, the display immediately jumps to the spot.

```

M:MP02____
-----
MEASURING POINT
```

Use the  or  keys to select the position within the term.

Use the  or  buttons to select letters, numbers and some special characters.

After confirming the entry by pressing the  key, you will be taken to the following display.

Entering / changing the oil type

```
  O:HLP46_____
  OILTYPE
```

After the selection, the display immediately jumps to the spot.

Use the ◀ or ▶ keys to select the position within the term.

Use the ▲ or ▼ buttons to select letters, numbers and some special characters.

After confirming the entry by pressing the ✓ key, you will be taken to the following display.

Info text / editing

```
  I:_____
  INFOTEXT
```

After the selection, the display immediately jumps to the spot.

Use the ◀ or ▶ keys to select the position within the term.

Use the ▲ or ▼ buttons to select letters, numbers and some special characters.

Press the ✓ key to return to the display "Entering / changing the measuring point"

User menu

The user menu is used to enter user names.

Up to five users can be stored.

These data are stored and can be queried (see Chapter 9.2.5.1 "Memory menu" / under "Measuring info").

Use the ▲ or ▼ button to select one of the five users for editing.

```
  [ ] user1      ▲
  [ ] user2      ▼
  [ ] user3
  OILTYPE
```

Use the ✓ button to select the respective user to be edited by setting a check mark. This user is then active and appears on the printout.

Pressing the ✓ button again, allows you to name the selected user.

```
  [x] user2_____
  OILTYPE
```

Use the ◀ or ▶ keys to select the position within the term.

Use the ▲ or ▼ buttons to select letters, numbers and some special characters.

After confirming the entry by pressing the ✓ button, you return to the user menu.

Press the ✕ button to go up one level.

### 9.2.5.3 System settings

Press the  or  button to select the desired menu item.

Press the  button to return to the main menu.

```
Setup homescreen ▲
▶ Setup Printout ▼
Display ▼
-----
TIME

Time / date ▲
▶ Language ▼
-----
TIME
```

### 9.2.5.4 Select start screen

This menu selects the data to be displayed on the start screen.

```
1: T ▲
▶ 2: P ▼
3: ISO 4/6/14/21 ▼
-----
SETUP HOMESCREEN

2: P ▲
▶ 3: ISO 4/6/14/21 ▼
4: Disabled ▼
-----
SETUP HOMESCREEN
```

For this purpose, four lines are provided, each of which can be assigned with one of the following values:

Each of the four values listed above can be selected by pressing the  and  keys.

The expression "disabled" in the example above means that no value is displayed in the fourth line of the start screen (see "disabled").

For each of the four value lines, the following selection possibilities exist.

Press the  button to enter the system setup menu.

Confirm the selection of the value line to be edited by pressing the  key.

The following menu appears:

Here, the selectable parameters are divided according to their function into:

```
Oilcondition ▲
▶ Oilcontamination ▼
Pressure ▼
-----
SETUP HOMESCREEN

Defined types ▲
▶ Disabled ▼
-----
SETUP HOMESCREEN
```

The respective value can be selected using the  or  key.

Press the  button to return to the start screen menu.

Confirm the selection by pressing the  button.

The following parameters can be selected:

#### Oil condition

Here, parameters can be selected which describe the oil condition.

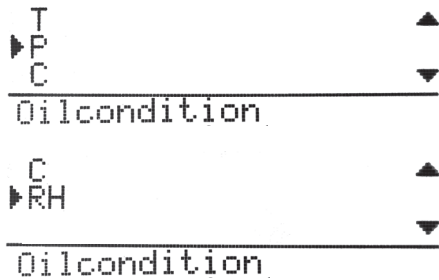

The respective parameter can be selected using the  or  key.

Press the  button to return to the start screen menu.

Confirm the selection by pressing the  button.

This parameter, which describes the oil state, thus appears at the correspondingly selected location on the start screen.

#### Oil contamination

Parameters which describe the oil contamination can be selected here.

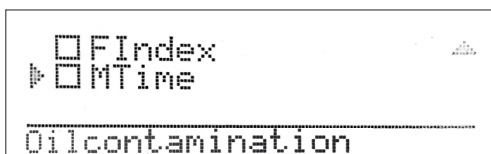
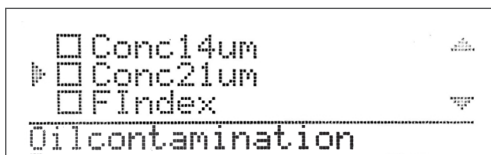
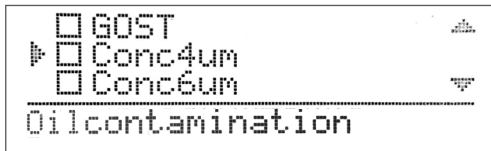
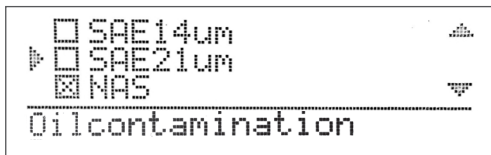
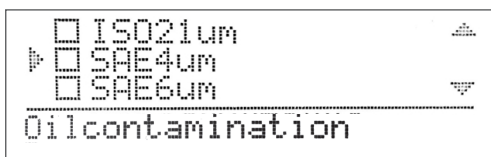
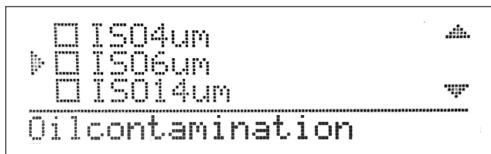



### 9.2.5.5 Print selection

In this menu you can select the data to be displayed on a short print. Here, the selectable parameters are divided according to their function into:

```
Oilcondition      ▲
▶Oilcontamination
Pressure          ▼
-----
SETUP PRINTOUT
```

```
Pressure          ▲
▶Defined types
-----
SETUP PRINTOUT
```

The respective value can be selected using the  or  key.

Confirm the selection by pressing the  button.

Press the  button to return to the system setup menu.

The following parameters can be selected:

Oil condition

Here, parameters can be selected which describe the oil condition.

```
T                ▲
▶P
C                ▼
-----
Oilcondition
```

```
C                ▲
▶RH
-----
Oilcondition
```

The respective value can be selected using the  or  keys.

Press the  button to return to the selection print menu.

The parameters can be selected with the  button and deselected again. Selected parameters are marked with a small x. This parameter, which describes the oil state, thus appears on the short print.

Oil contamination

Parameters which describe the oil contamination can be selected here.

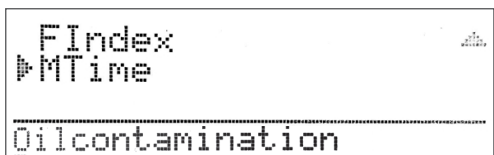
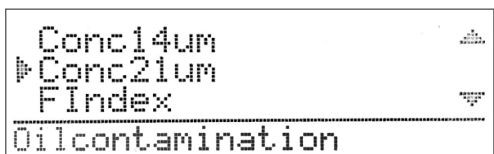
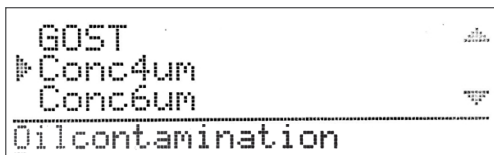
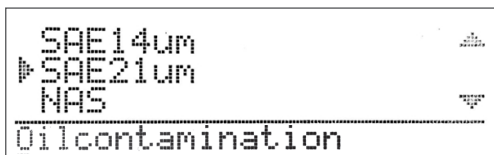
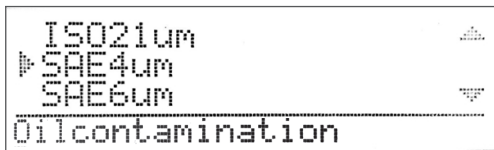
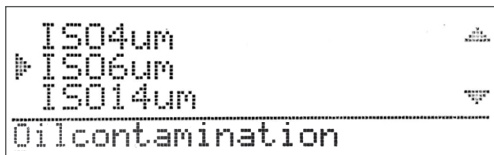

The respective parameter can be selected using the  or  key.

Press the  button to return to the selection print menu.

Confirm the selection by pressing the  button.

This parameter, which describes the oil state, thus appears on the short print.

Defined parameters

Here, in the device predefined (stored) parameters can be selected.



Confirm the selection by pressing the  button.

Press the  button to return to the selection print menu.

The indication of the defined parameters thus appears on the short print.

### 9.2.5.6 Display

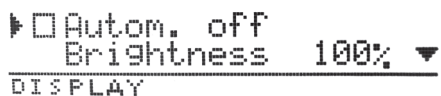

Here, the display can be configured so that the lightning switches off automatically after a certain time. In addition, the brightness of the lightning can be adjusted.

The automatic brightness setting of the display can be selected with the  key by setting a check mark.

Use the  or  buttons to select the menu items.

Press the  button to return to the system setup menu.

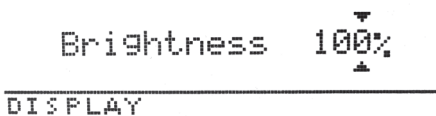

Here you can adjust the brightness of the display background lighting in %.

Use the  or  button to select the item to be changed.

Use the  or  button to raise or lower the values.

Pressing the  button returns you to the display settings menu without accepting the settings.

The settings are set by pressing the  button.

### 9.2.5.7 Time / date

Here you can set the time and date.

```
▶Time    09:54:24
Date    22.10.13
-----
TIME / DATE
```

Use the  or  button to select the time or date.

Confirm the selection by pressing the  button.

Press the  button to return to the system setup menu.

```
Time    09:54:30
-----
TIME / DATE
```

Here you can set the time.

Use the  or  button to select the item to be changed.

Use the  or  button to raise or lower the values.

takes the new value,

discards the new value.

```
Date    22.10.13
-----
TIME / DATE
```

Here you can set the date.

Use the  or  button to select the item to be changed.

Use the  or  button to raise or lower the values.

takes the new value,

discards the new value.

### 9.2.5.8 Language

Here the language of the display representations can be selected. Currently supported are: German, English and French.

```
☒English    ▲
▶☐Deutsch
☐Francais  ▼
-----
LANGUAGE
```

Use the  or  button to select the language.

The language can be selected by pressing the  key.

Press the  button to return to the system setup menu.



**CAUTION**

**Penetrating dirt and liquids can lead to malfunctions**

Premature wear - malfunctions - risk of damage - property damage.  
The safe function of the OPCom Portable Oil Lab is thus no longer guaranteed.

- ▶ Ensure absolute cleanliness when working at the hydraulic system.
- ▶ Do not use a high-pressure cleaner.

**Damage to the surface by solvents and aggressive detergents.**

Aggressive detergents may damage the seals of the OPCom Portable Oil Lab and let them age faster.

- ▶ Never use solvents or aggressive detergents.
- ▶ Do not use a high-pressure cleaner.

**Damage to the hydraulic system and the seals**

The water pressure of a high-pressure cleaner can damage the hydraulic system and the seals of the OPCom Portable Oil Lab. The water displaces the oil from the hydraulic systems and the seals.

- ▶ Do not use a high-pressure cleaner for cleaning.

Close all openings with suitable protective caps / protections.

Check that all seals and caps of the plug-in connections are secure, so that no humidity can penetrate into the OPCom Portable Oil Lab.

Clean the OPCom Portable Oil Lab only with a dry, lint free tissue.

**10.1 Maintenance**

The Particle Monitor OPCom Portable Oil Lab is maintenance-free if you use it as intended.

**NOTE**

Please note that the device must be subjected to an annual calibration by the manufacturer. If this calibration is not carried out, the warranty expires.

**10.2 Repair**

ARGO-HYTOS offers a comprehensive range of services for the repair of the OPCom Portable Oil Lab. Spare parts are not offered.

Repairs to the OPCom Portable Oil Lab may only be carried out by the manufacturer or authorized distributors and subsidiaries. There is no guarantee for self-initiated repairs.

**10.3 Spare parts**

The following spare parts are available for the Particle Monitor OPCOM Portable Oil Lab:

Description	Part No.
Set, cover for SD and USB	PPCO 300-5090
Hose set with couplings	PPCO 300-5050
Minimess hose 2m M16x2	PPCO 100-5280
Paper rolls for thermal printer	SCSO 900-5075
Power supply	PPCO 300-5120
Power cable	PPCO 300-5130
Protection caps (2x)	PPCO 300-5080
Suction connection	PPCO 300-5060
Protective strainer	PPCO 300-5070

The software LubMon PC<sub>light</sub> and LubMon Config can be downloaded from the website [www.argo-hytos.com](http://www.argo-hytos.com). The components are to be prepared as follows:

Software installation LubMon PC<sub>light</sub> / LubMon Config

1. Unpack the LubMonPClight.zip or LubConfig.zip file on your computer.

Data acquisition via USB

3. Connect the USB cable with the USB-B connector to the portable particle monitor.
4. Connect the USB cable with the USB-A connector to your computer. When connected to the computer, a new virtual COM port is created. If necessary, you can check the assignment of the virtual COM port in the Windows Device Manager.
5. LubMon PC<sub>light</sub> or LubMon Config can be started by double click on the LubMonPClight.exe or LubMonConfig.exe file. Select the previously installed COM port in the settings of LubMon PC<sub>light</sub>.

LubMon PC<sub>light</sub>

LubMon PC<sub>light</sub> is used for continuously reading and displaying the measurement data of the OPCom Portable Oil Lab. A selection of the measurement data appears on the left side of the window. On the right side of the window, the data can be visualized in two diagrams.

Please note that the data of the OPCom Portable Oil Lab are only updated after the set measuring time has elapsed.

LubMon Config

LubMon Config is used for a unique readout of the current measured data (no continuous representation) and for readout of the memory as well as for configuring the OPCom Portable Oil Lab.

For a detailed description of the two programs please refer to the respective manual.

The Particle Monitor OPCOM Portable Oil Lab is a component that does not have to be taken out of service. Therefore, the chapter in this guide does not contain any information.

This chapter does not contain any information for your device.



### 14.1 Environmental protection

Careless disposal of the OPCom Portable Oil Lab and the pressure fluid can lead to pollution of the environment. Therefore dispose of the OPCom Portable Oil Lab and the pressure fluid in accordance with the national standards of your country.

Dispose of pressure fluid residues according to the respective safety data sheets for these pressure fluids.

Batteries with the symbol shown below must not be fed to the normal waste collection, end users are legally obliged to return used batteries.



Waste batteries may contain hazardous substances which, if not properly stored or disposed of, may damage the environment or human health. However, batteries contain different recyclable materials and must be collected and recycled separately.

After use, the batteries we use can be returned either:

In accordance with the EC Directive 2000/96 / EC, the device must be disposed of in an orderly manner at the end of its service life. In doing so, recyclable materials are recycled to avoid the pollution of the environment. Route the appliance to a collection point for electronic waste.

## 15. Extension and conversion

Do not modify the Particle Monitor OPCom Portable Oil Lab.

### NOTE

The warranty of ARGO-HYTOS applies to the delivered configuration and extensions, which were taken into account during configuration.  
The warranty expires after a conversion or extension that goes beyond the conversions or extensions described here.

### 15.1 Accessories

For the Particle Monitor OPCom Portable Oil Lab you get the following accessories (not included in the scope of delivery):

Description	Part No.
Carrying bag*	PPCO 200-5020
Carrying strap	PPCO 200-5010
SD card	SCSO 900-5050
SD card reader	SCSO 900-5040
USB cable USB-A / USB-B	SCSO 900-5060
Power cable with non-European plugs	on request

\* with space for accessories (power supply, hoses, ...)



Fig. 17: OPCom Portable Oil Lab with carrying bag and carrying strap

### 16.1 Basic procedures

- › You should also be systematic and targeted under time pressure.  
Random, thoughtless dismantling and adjustment of setting values can lead to a point where it is no longer possible to determine the original problem.
- › Get an overview of the function of the Particle Monitor OPCom Portable Oil Lab in connection with the overall system.
- › Try to clarify whether the product had performed the required function in the overall system before the fault occurred.

Try to record changes to the overall system in which the Particle Monitor OPCom Portable Oil Lab is installed:

- › Have the application conditions or the application range of the Particle Monitor OPCom Portable Oil Lab been changed?
- › Have modifications (e.g. retrofits) or repairs been carried out to the entire system (machine / system, electrical system, control system) or to the product? If yes, which modifications?
- › Has the product / machine been operated as intended?
- › How does the malfunction tend to show?
- › Form a clear idea of the cause of the problem. If necessary, consult the immediate operator.

If you cannot correct the error, please contact one of the contact addresses to be found at [www.argo-hytos.com](http://www.argo-hytos.com).

If the unit should not accept any more entries, turn it off briefly and then turn it on again after a few seconds. After initialization, the particle monitor continues as usual.

<b>Error</b>	<b>No function</b>
Cable is not correctly connected	First check the correct electrical connection of the device.
<b>Error</b>	<b>No serial communication.</b>
Wrong communication port selected Cable wrong or defective	Check and correct the selection of the communication port (e.g. COM1). Use ARGO-HYTOS data cables if possible.
<b>Error</b>	<b>Identical cleanlinesses are displayed on all values. Laser current high / photovoltage low.</b>
Air in the oil	Connect the OPCom Portable Oil Lab on the pressure side. Increase the distance from the pump.
Cell contaminated	Clean the OPCom Portable Oil Lab with clean oil or solvents such as Isopropanol.

Table 4: Error description

## 17. Technical data

Parameter	Size	Unit
Operating pressure		
High-pressure connection <sup>1</sup>	10 ... 320 (145 ... 4,600)	bar (psi)
With pump operation	0	bar (psi)
Viscosity range fluid <sup>2</sup>		
Operating temperature range fluid	0 ... +60 (+32 ... +140)	°C (°F)
Operating conditions		
Temperature	-10 ... +60 (+14 ... +140)	°C (°F)
Rel. humidity	0 ... 95	% r.H. (non-condensing)
Compatible fluids		
	mineral oils (H, HL, HLP, HLPD, HVLP), synthetic esters (HETG, HEPG, HEES, HEPR), polyalkylenglycols (PAG), zinc and ash-free oils (ZAF), polyalphaolefins (PAO)	
Wetted materials		
	chrome, aluminum, stainless steel, Viton, steel, brass, HNBR, NBR, polyurethane resin, epoxy resin, chemical nickel/gold (ENIG), soldering tin (Sn96, 5Ag3CuO, 5NiGe), aluminum oxide, glass (DuPont QQ550), gold, silver-palladium, sapphire, PVC (hoses)	
Power supply device		
Power supply	24	VDC
Power consumption	max. 8	A
Power supply for the according power adaptor		
Power supply	100 ... 240	VAC (50/60 Hz)
Power consumption	max. 4	A
Power at 24VDC-output	max. 221	W
Characteristics battery		
Nominal capacity	7500	mAh
Loading time	< 1	h
Running time when measuring without pump (when measuring with pump the running time decreases depending on the oil viscosity)	> 24	h
Display particle measurement		
ISO 4406:99	0 ... 28 (calibrated area 10 ... 22)	ordinal number (OZ)
SAE AS 4059E	000 ... 12	ordinal number (OZ)
NAS 1638 (based) <sup>3</sup>	00 ... 12	ordinal number (OZ)
GOST 17216 (based) <sup>3</sup>	00 ... 17	ordinal number (OZ)
Size channels	4, 6, 14, 21	µm(c)
Measuring range oil parameter		
Rel. permittivity	1 ... 7	-
Rel. humidity	0 ... 100	%
Conductivity	100 ... 800000	pS/m
Temperature	-20 ... +120 (-4 ... +248)	°C (°F)
Measuring accuracy		
Particle measurement (within calibr. range) - ISO 4 / ISO 6	± 1	ordinal number (OZ)
Particle measurement (within calibr. range) - ISO 14 / ISO 21	± 2	ordinal number (OZ)
Rel. dielectric number <sup>4</sup>	± 0.015	-
Rel. humidity (10 ... 90%) <sup>5</sup>	± 3	% r.H.
Rel. humidity (<10 %, >90%) <sup>5</sup>	± 5	% r.H.
Conductivity (100 ... 2000 pS/m)	± 200	pS/m
Conductivity (2000 ... 800000 pS/m)	Typ. < 10	%
Temperature	± 2	K

<sup>1</sup> Depending on the oil viscosity

<sup>2</sup> Depending on the permissible operating pressure

<sup>3</sup> From software version 1.70.15 upwards

<sup>4</sup> Calibrated to n-Pentan at 25 °C (77 °F)

<sup>5</sup> Calibrated to air at room temperature

17.1 Dimensional drawing

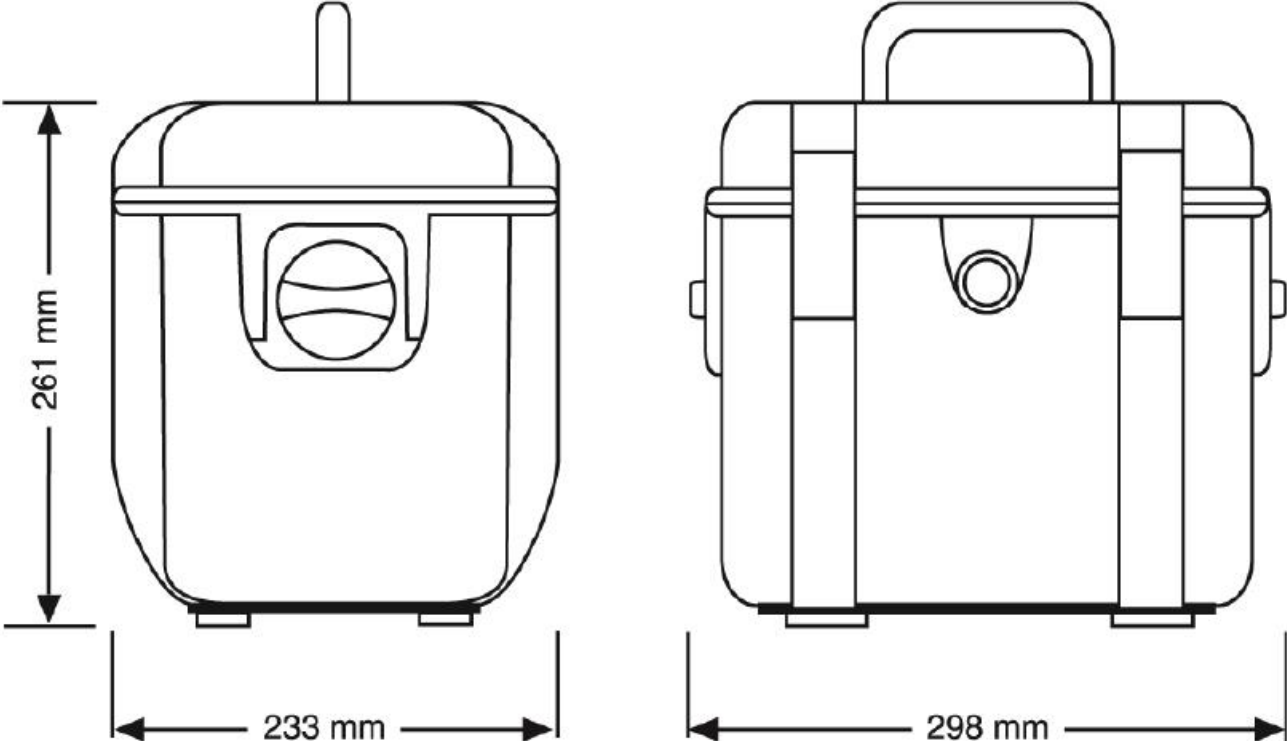

Fig. 16: Dimensional drawing

18.1 Declaration of conformity

**EU - Konformitätserklärung**  
EU - Declaration of Conformity



**ARGO-HYTOS GMBH**  
Industriestraße 9  
76703 Kraichtal-Menzingen

Tel.: +49 72 50 / 76 0  
Fax: +49 72 50 / 76 199  
www.argo-hytos.com

Die EU - Konformitätserklärung gilt für folgendes  
Gerät:

Öl analysesystem

The EU - Declaration of Conformity applies to  
the following unit:

Oil Analysis System

**OPCom Portable Oil Lab**  
PPCO 300-1000

Wir bestätigen die Übereinstimmung mit den  
wesentlichen Anforderungen der europäischen  
Richtlinie(n):

**EMV Richtlinie: 2004/108/EG**  
(gültig bis 19.04.2016)

**EMV Richtlinie: 2014/30/EU**  
(gültig ab 20.04.2016)

We confirm the conformity according to the  
essential requirements of the European  
directive(s):

**EMC Directive: 2004/108/EC**  
(valid until 19/04/2016)

**EMC Directive: 2014/30/EU**  
(valid from 20/04/2016)

Folgende Norm(en) wurde(n) angewandt:

The following standard(s) was (were) applied:

**EN 61326-1:2013**  
**EN 61326-2-2:2013**

Die Beurteilung und Prüfung des Gerätes erfolgte  
durch das EMV-Prüflabor:

The evaluation and testing of the device was  
carried out by the EMC testing laboratory:

**SCHWILLE - ELEKTRONIK**  
**Produktions- und Vertriebs GmbH**  
**Benzstrasse 1 A**  
**85551 Kirchheim / Germany**

Kraichtal, 14.04.2016

(Ort und Datum der  
Ausstellung)

(Place and date of issue)

(Unterschrift) Roman Krähling/  
Dokumentenverantwortlicher

(Signature) Roman Krähling /  
Responsible for documents

(Unterschrift ) Dr. Marcus Fischer/  
Technischer Geschäftsführer

(Signature) Dr. Marcus Fischer/  
Technical director

International

## ARGO-HYTOS worldwide

Benelux	ARGO-HYTOS B.V.	info.benelux@argo-hytos.com
Brazil	ARGO-HYTOS Fluid Power Systems Ltda.	info.br@argo-hytos.com
China	ARGO-HYTOS Fluid Power Systems	info.cn@argo-hytos.com
Czech Republic	ARGO-HYTOS s.r.o ARGO-HYTOS Protech s.r.o	info.cz@argo-hytos.com info.protech@argo-hytos.com
France	ARGO-HYTOS SAS	info.fr@argo-hytos.com
Germany	ARGO-HYTOS GMBH	info.de@argo-hytos.com
Great Britain	ARGO-HYTOS Ltd.	info.uk@argo-hytos.com
Hong Kong	ARGO-HYTOS Hong Kong Ltd.	info.hk@argo-hytos.com
India	ARGO-HYTOS PVT. LTD.	info.in@argo-hytos.com
Italy	ARGO-HYTOS S.r.l.	info.it@argo-hytos.com
Poland	ARGO-HYTOS Polska spz o.o.	info.pl@argo-hytos.com
Sweden	ARGO-HYTOS Nordic AB	info.se@argo-hytos.com
Turkey	ARGO-HYTOS Hidrolik Ekip. San. ve Tic. Ltd. Şti.	info.tr@argo-hytos.com
USA	ARGO-HYTOS Inc.	info.us@argo-hytos.com

