

Clogging Indicators

DG 023 · DG 024 · DG 041 · DG 042

for Pressure and High Pressure Filters · Operating pressure up to 450 bar / 6527 psi · Response / switching pressure up to 5.0 bar / 73 psi

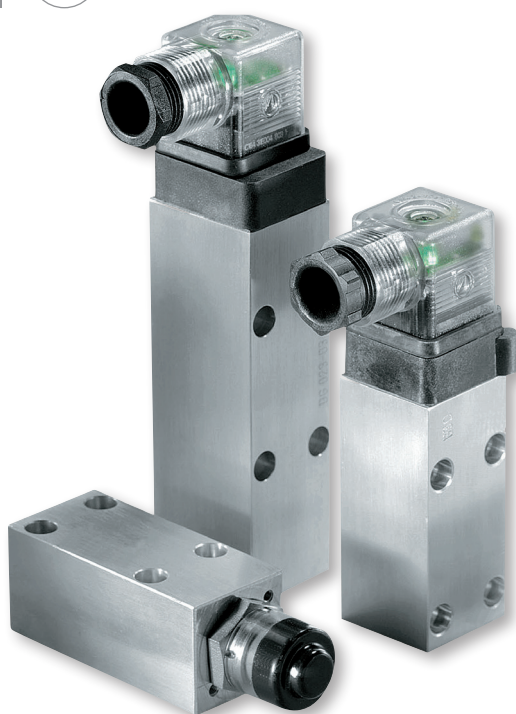

Clogging Indicators

Description

Application

Monitoring the contamination of pressure and high pressure filters.

General

Filter elements installed in hydraulic filters remove dirt from a hydraulic system and therefore become contaminated themselves. Free pores or spaces in the filter material are obstructed by dirt particles, which causes a continuous increase in the pressure loss.

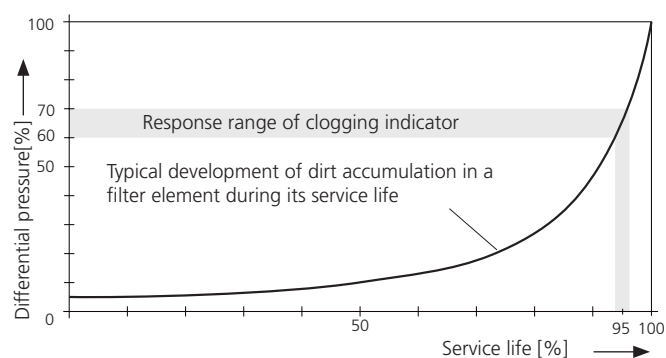

The dirt load collected in a filter element gradually increases during service, which also leads to a higher pressure drop. The resulting differential pressure Δp is monitored by a clogging indicator. Once a preset value is reached, an electrical and / or optical signal is generated.

The following must be observed in this context:

The pressure drop caused by the filter element increases depending on the flow rate, the dirt load, and the viscosity of the pressure fluid.

Therefore, a filter element is not regarded contaminated before the clogging indicator responds at operating temperature of the hydraulic system, causing a continuous signal.

Consequences of an overdue filter element change

For filters equipped with a bypass valve:

The more dirt has collected in the filter element, the more frequently the bypass valve opens and part of the hydraulic fluid remains unfiltered. The high pressure loss causes unnecessary power consumption.

For filters without a bypass valve:

The increasing pressure loss across the filter element, which reduces the efficiency of the hydraulic system, eventually causes malfunctions to occur or a pressure relief valve to respond.

Design and principle of operation

Within the clogging indicator, the differential pressure $\Delta p = p_1 - p_2$ (pressure upstream of the element minus pressure downstream of the element) caused by the filter element acts on a magnetic piston against the force of a spring. In optical (mechanical) clogging indicators, the increasing differential pressure causes the piston to approach a second magnet with reversed polarity which in turn causes the indicator to change from green to red. In electrical clogging indicators, the magnetic piston triggers a reed switch.

Special design features

Piston seal:

The piston actuated by the differential pressure is equipped with a leak-free O-ring seal. As a result, the total flow passes the filter element.

Proximity position sensing:

Piston movement is detected by sensing a magnetic field, i.e. without mechanical contact. For this reason, ARGO-HYTOS clogging indicators are absolutely leakfree.

Characteristics

Operating pressure

0 ... 315 bar / 4570 psi, min. 10^7 pressure cycles
Nominal pressure according to DIN 24550

0 ... 450 bar / 6527 psi, min. 10^4 pressure cycles
Quasi-static operating pressure

Connection

For the flange hole layout please refer to the section Dimensions (other fittings on request).

Hydraulic fluids

Mineral oil and biodegradable fluids (HEES and HETG, see info-sheet 00.20).

Temperature range of fluids

-30 °C ... +100 °C (short term +125 °C)
-22 °F ... +212 °F (short term +257 °F)

Ambient temperature range

-30 °C ... + 80 °C
-22 °F ... +176 °F

Materials

Housing:	Aluminum alloy
Piston:	Brass
Socket:	Polyamide
Display piece DG 042:	Polyamide
Seals:	NBR (FPM on request)

Operating voltage

10 ... 30 V DC
(only required for clogging indicators with built-in LEDs).

Electrical service life

Min. 10^7 switching cycles

Electrical protection

IP 65 (with mounted and secured socket)

Mounting position

No limitation

DG 042 - Optical differential pressure indicator

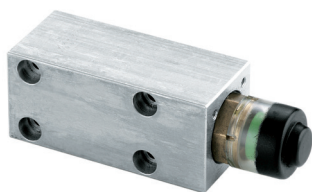

Function:

When the preset differential pressure is reached, the optical indicator changes from green to red. If the pressure differential returns to a value below the preset limit, the indicator changes back to green, i.e. no manual reset of the indicator is required.

DG 041-Electrical differential pressure switch (change-over)

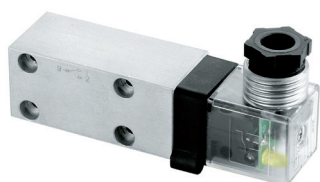

Function:

When the preset differential pressure is reached, the built-in Reed switch changes over.

The change-over (CO) switch makes it possible to indicate a broken wire by means of a suitable electronic circuit, as compared to a make contact (normally open NO) switch.

Option:

The transparent socket with 2 built-in LEDs makes it possible to have an additional optical indication of the filter contamination. When the operating voltage is switched on, a green LED lights up. When the switching pressure is reached, a yellow LED lights up in addition.

DG 023 - Electrical differential pressure switch with temperature suppression (change-over)

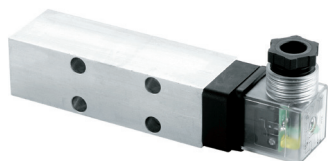

Function:

The built-in Reed switch changes over when the preset differential pressure is exceeded.

If the temperature drops below 32 °C / 90 °F, a temperature switch opens and suppresses the signal of the differential pressure switch.

The transparent socket with 2 built-in LEDs makes it possible to have an additional optical indication of the filter contamination (function described at DG 041).

DG 024 - Electrical differential pressure switch with 2 switching points (break)

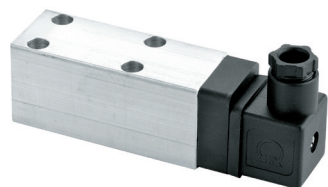

Function:

When 70% of the preset differential pressure is reached, the first Reed switch opens, at 100% the second built-in Reed switch opens.

Note:

Since the differential pressure of a filter element rises at an exponential rate towards the end of the element's service life (refer to the Description section), approximately 95% of the service life has expired when the first Reed contact opens (at 70% of Δp setting).

Selection Chart

Part no.	Optical indicator			Electrical switch		Response/switching pressure S_2 / S_3	Type of contact	Switching voltage U	Switching current I	Switching power P	Symbol		Remarks
	Temperature suppression < +32 °C / +90 °F	S_1	bar	psi	kg						lbs		
1	2	3	4	5		6	7	8	9	10	11		12
DG 042-01¹	•	-	-	2.0	29	-	-	-	-	1	0.17	0.37	-
DG 042-02¹	•	-	-	5.0	73	-	-	-	-	1	0.17	0.37	-
DG 041-61	-	•	-	1.2	17	change-over	120/175	0.17/0.25	3.5/5.0	2	0.19	0.42	with socket
DG 041-31¹	-	•	-	2.0	29	change-over	120/175	0.17/0.25	3.5/5.0	2	0.19	0.42	with socket
DG 041-44	•	•	-	2.0	29	change-over	- /30	- /0.25	- /3.0	3	0.19	0.42	with socket
DG 041-32¹	-	•	-	2.5	36	change-over	120/175	0.17/0.25	3.5/5.0	2	0.19	0.42	with socket
DG 041-33¹	-	•	-	5.0	73	change-over	120/175	0.17/0.25	3.5/5.0	2	0.19	0.42	with socket
DG 041-43	•	•	-	5.0	73	change-over	- /30	- /0.25	- /3.0	3	0.19	0.42	with socket
DG 023-03	•	•	•	2.0	29	change-over	- /30	- /0.25	- /3.0	4	0.34	0.75	with socket
DG 023-02	•	•	•	5.0	73	change-over	- /30	- /0.25	- /3.0	4	0.34	0.75	with socket
DG 024-02	-	•	-	3.5/5.0	51/73	break	120/175	0.17/0.25	3.5/5.0	5	0.27	0.60	with socket

¹ Preferred type, no minimum order quantity required

Remarks:

- › The response / switching pressure of the clogging indicator must be lower than the cracking pressure of the bypass valve of the filter.
- › The clogging indicators listed in this chart are standard units. Other designs available on request.
- › Mounting accessories are not included in the scope of delivery and must be ordered separately (Part-no. see spare parts).
- › Reed switches are sensitive of excessively strong currents. Even a short-term overload causes an increased contact resistance or failure of the switch. By taking the following precautions, premature failure of Reed switches due to overload is avoided.
- › When ordering pressure and high-pressure filters incl. clogging indicator (code "M" in the order code), the clogging indicators are enclosed separately. Installation accessories and installation instructions are included.

Wiring suggestions:

Current limiter for DC and AC voltage:

If light bulbs or other loads are connected over long distances (conductor capacity!), a protective resistor should be connected in series in order to limit the current. The same applies when capacitance loads are connected.

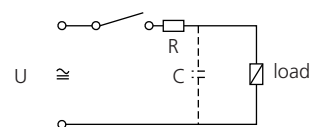

Spark suppression in DC applications:

The contacts of Reed switches open extremely fast, causing voltage peaks to be induced when switching off inductive loads, such as relays, lifting magnets, or solenoid valves. The resulting self-induction currents are short-circuited by connecting a diode in parallel to the inductive load.

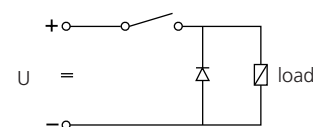

Spark suppression in AC applications:

In AC applications, a diode connected in parallel to the load is not sufficient. RC elements should be used here, connected in parallel to the Reed switch. Please contact our design engineers for advice in order to select a suitable RC element.

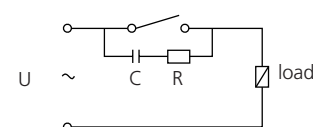

Dimensions

DG 042

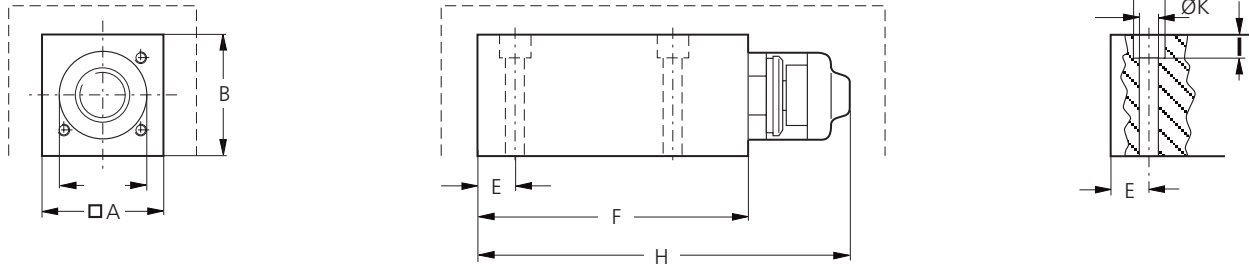

DG 041

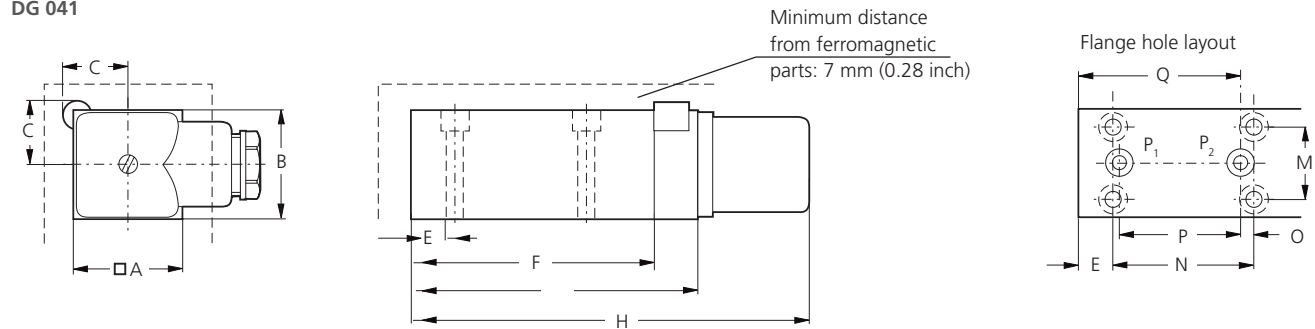

DG 023 / DG 024

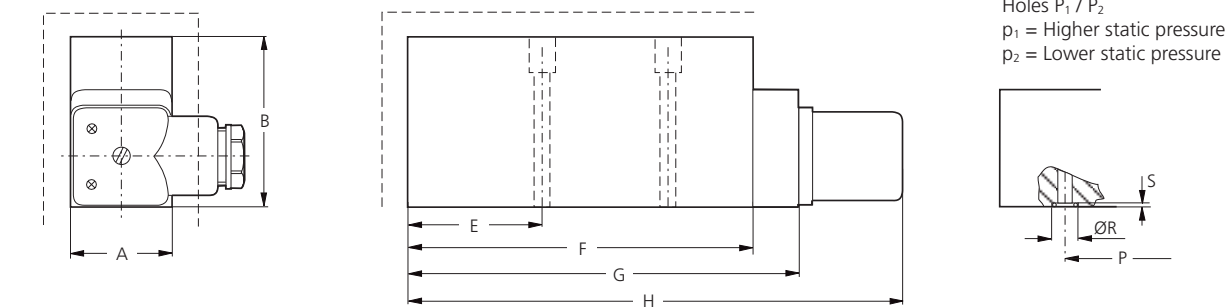

Measurements in mm

Type	A	B	C	E	F	G	H	I	K	L	M	N	O	P	Q	R	S	T	U
DG 042	30	30	21.5	8	67	-	93	6	4.5	8	20	39	3	34	44	7.2	1.1	M4	6
DG 041	30	30	17.5	11	70	83	115	6	4.5	8	20	39	3	34	47	7.2	1.1	M4	6
DG 023	30	50	-	12	76	88	121	6	4.5	8	20	39	3	34	48	7.2	1.1	M4	6
DG 024	30	35	-	9	77	89	122	11	4.5	8	20	39	3	34	45	7.2	1.1	M4	6

Measurements in inch

Type	A	B	C	E	F	G	H	I	K	L	M	N	O	P	Q	R	S	T	U
																		mm	
DG 042	1.18	1.18	0.85	0.31	2.64	-	3.66	0.24	0.18	0.31	0.79	1.54	0.12	1.34	1.73	0.28	0.04	M4	0.24
DG 041	1.18	1.18	0.69	0.43	2.76	3.27	4.53	0.24	0.18	0.31	0.79	1.54	0.12	1.34	1.85	0.28	0.04	M4	0.24
DG 023	1.18	1.97	-	0.47	2.99	3.46	4.76	0.24	0.18	0.31	0.79	1.54	0.12	1.34	1.77	0.28	0.04	M4	0.24
DG 024	1.18	1.38	-	0.35	3.03	3.50	4.80	0.43	0.18	0.31	0.79	1.54	0.12	1.34	1.77	0.28	0.04	M4	0.24

Symbols

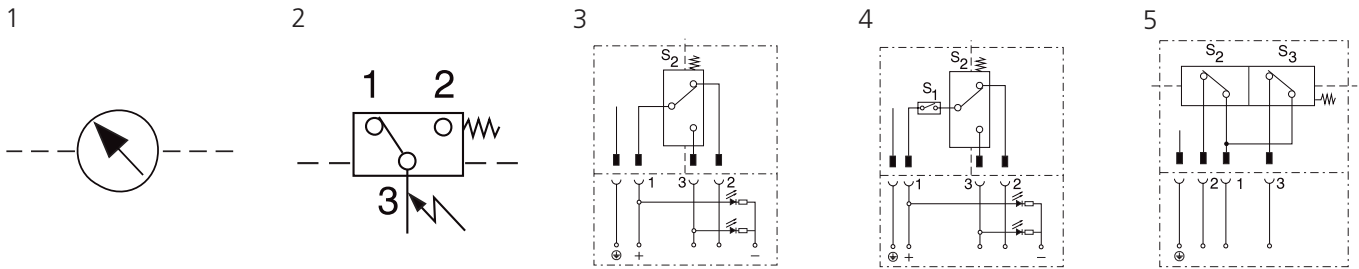

Spare Parts

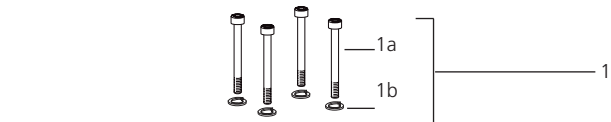

DG 042

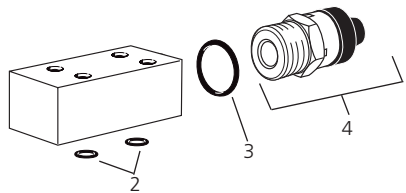

DG 041 / DG 024

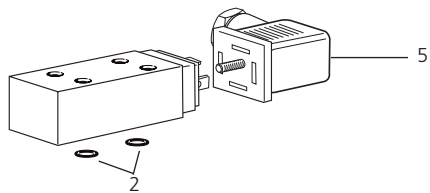

DG 023

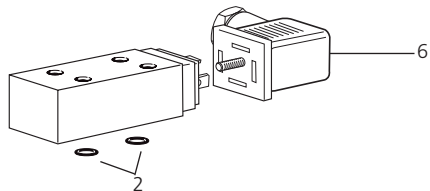

Pos.	Designation	Part No.
1	Mounting accessories * for versions without temperature compensation	DG 020.1710
1	Mounting accessories * for versions with temperature compensation	DG 020.1730
1a	Bolt* M4 x 30 DIN 912-8.8	11272600
1a	Bolt* M4 x 50 DIN 912-8.8	18077800
1b	Spring washer* B4 DIN 127	11272700
2	O-ring 4.5 x 1.5 mm 0.18 x 0.06 inch	N007.0041
3	O-ring 12.3 x 2.4 mm 0.48 x 0.09 inch	N007.0124
4	Display piece assy (incl. pos. 3)	DG 042.1410
5	Socket DIN 43650 - AF3	DG 041.1220
6	Socket with 2 LED DIN 43650 - AF3	DG 041.1200

*Not included in basic unit

The functions of the complete filters as well as the outstanding features of the filter elements assured by ARGO-HYTOS can only be guaranteed if original ARGO-HYTOS spare parts are used.

Quality Assurance

Quality management according to DIN EN ISO 9001

Various quality controls during the production process guarantee the leakfree function and solidity of our products.

Illustrations may sometimes differ from the original. ARGO-HYTOS is not responsible for any unintentional mistake in this specification sheet.